



# SMART CHARGING SYSTEMS

*A guide brought to you by Remy®*



**BBB**  
INDUSTRIES®



# A Good Day Starts with a Smooth Start.

---

*Trusted brand for high performance starters and alternators*

## The Start

In 1896, the Remy brothers developed the Remy Magneto to power the first vehicles. By 1912, the Remy Magneto and Dynamos evolved to a self-starting cranking system and the Remy brothers began developing plans for other products.

## Over a century of Reliability

More than 100 years later, the legendary product originally created by Remy lives on in the aftermarket world of rotating electrical products.

## A Tradition of Innovation

The Remy brand brings trust and expertise to all new and remanufactured starters and alternators for the automotive aftermarket.

## High Performance Products And High-Level Service

The acquisition of the Remy brand by BBB Industries combines a nationally recognized brand with a company that delivers on the expectations of its partners and customers.

Technical Support Available Monday to Friday

7am CST to 7pm CST

**1-800-280-2737**



# Index

---

<b>Check the Basics First</b>	<b>1</b>
<b>Types of Batteries</b>	<b>1</b>
<b>Battery Charging</b>	<b>2</b>
<b>Essential Test Equipment</b>	<b>3</b>
<b>Voltage Drop Testing</b>	<b>4</b>
<b>Controller Area Network (CAN)</b>	<b>6</b>
<b>Local Interconnect Network (LIN)</b>	<b>6</b>
<b>Ford Smart Regenerative Charge System</b>	<b>7</b>
<b>GM Regulated Voltage Control (RVC) Computer Controlled Charging</b>	<b>10</b>
<b>Chrysler Computer Controlled Charging</b>	<b>12</b>
<b>Toyota / Lexus</b>	<b>16</b>
<b>Hyundai / Kia AMS</b>	<b>17</b>
<b>Honda / Acura Dual Mode Charging System</b>	<b>18</b>

# Check the Basics First

**Verify that the Battery is correct for the vehicle & check state of charge.**

Batteries are perishable devices that eventually wear out as they deteriorate and become incapable of performing their job. In addition, new and/or good batteries may become discharged for various reasons. Because of this, a battery check should be the starting point for diagnosing all electrical system problems.

- Look for loose connections
- Corrosion
- Poor Grounds

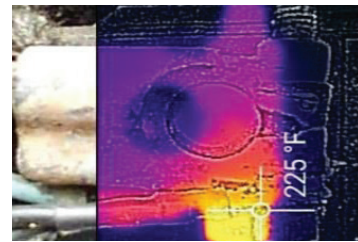

## Types of Batteries

**Wet Cell** (flooded); The electrolyte is liquid sulfuric acid.

**Gel Cell** with gel electrolyte; the sulfuric acid is mixed with fumed silica which makes the resulting mass gel-like and immobile. Unlike a flooded wet-cell lead-acid battery, these batteries do not need to be kept upright.

**Absorbed Glass Mat (AGM)**; AGM batteries differ from flooded lead acid batteries in that the electrolyte is held in the glass mats, as opposed to freely flooding the plates.

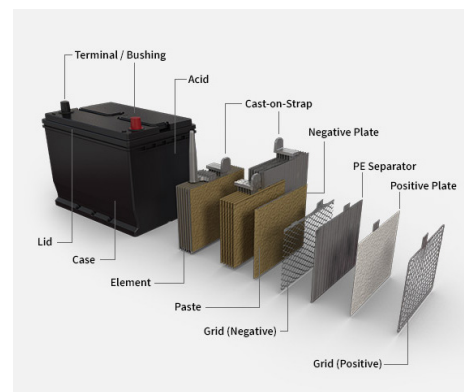

# Battery Charging

Many newer battery chargers, like the OPTIMA Chargers Digital 1200 12V Performance Battery Charger and Maintainer, have microprocessors that collect information from the battery and adjust the current and voltage accordingly.

Some have different settings for charging flooded, gel, and AGM batteries.

If you use the gel setting to charge an AGM battery, it won't fully charge. Over time, it could damage your AGM battery.

**Charging Rates and Times**

Open Circuit Voltage		CCA	5 Amp Charge Rate (in hours)	10 Amp Charge Rate (in hours)	30 Amp Charge Rate (in hours)
Below 11.85	200-300	200-300	8	4	2
	300-400	300-400	10	5	2.5
	400-500	400-500	12	6	3
	500-600	500-600	14	7	3.5
	600-700	600-700	16	8	4
11.85 - 12.00	200-300	200-300	5	2.5	1.25
	300-400	300-400	7	3.5	1.75
	400-500	400-500	9	4.5	2.25
	500-600	500-600	11	5.5	2.75
	600-700	600-700	13	6.5	3.25
12.00 - 12.10	200-300	200-300	3	1.5	0.75
	300-400	300-400	5	2.5	1.25
	400-500	400-500	7	3.5	1.75
	500-600	500-600	9	4.5	2.25
	600-700	600-700	11	5.5	2.75
12.10 - 12.25	200-300	200-300	2	1	0.5
	300-400	300-400	4	2	1
	400-500	400-500	5	2.5	1.25
	500-600	500-600	7	3.5	1.75
	600-700	600-700	9	4.5	2.25
12.25 - 12.35	200-300	200-300	1	0.5	—
	300-400	300-400	2	1	0.5
	400-500	400-500	3	1.5	0.75
	500-600	500-600	5	2.5	1.25
	600-700	600-700	7	3.55	1.75
Above 12.35	200-300	200-300	0.5	—	—
	300-400	300-400	1	0.5	—
	400-500	400-500	1.5	0.75	—
	500-600	500-600	2.5	1.25	0.75
	600-700	600-700	3.5	1.75	1

# Essential Test Equipment

---

## High-Current Battery Load Tester

Battery testers will draw current from the battery and check to see that the voltage does not drop below a specified value.

- The Sun VAT-40 had you draw half of the battery's CCA and load for 15 seconds.
- Residual voltage specification was the voltage did not drop below 9.6V.
- Newer vehicles specify a minimum voltage of 10.5V.

## Digital Voltage Tester

Modern digital voltage testers measure battery conductance.

- The tester runs AC current through the battery.
- The AC voltage response from the battery is compared to the input current.
- The ratio determines the conductance.



## Additional Equipment

To accurately diagnose any charging system, a well-equipped repair facility will require:

- DVOM
- Amp Clamps
- Battery Load testing equipment
- OBDII scan tool
- Service Literature
- Lab Scope



# Voltage Drop Testing

## *Solving the Root Causes of Charging System Failures*

Repeat charging system failures are most often traced to vehicle concerns. A voltage drop in the power or ground circuits of an alternator can cause premature failure and is often the source of misdiagnosis. To prevent early failures or reduced charging system voltage, you should always perform voltage drop tests as part of a charging system diagnosis. In this issue, we'll provide you the necessary information to accurately measure charging system voltage drop.

### What is voltage drop?

In every operating circuit, there is voltage used by each component, connection and wire. Figure 1 below shows a simple lamp circuit and normal voltage drops. Compare those readings to the ones in Figure 2, where the bulb is dimly lit. Excessive voltage is being used in the ground circuit to overcome the resistance, preventing the bulb from lighting up as brightly.

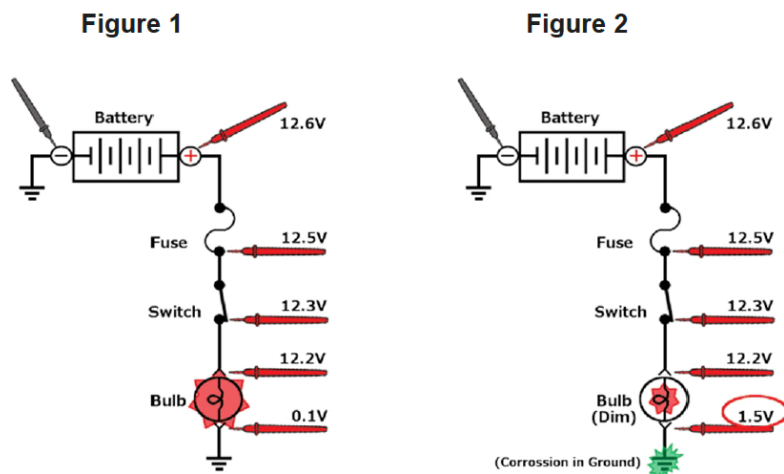

Voltage drop in the charging system can cause multiple symptoms, depending upon the location of the voltage drop:

- Undercharge or overcharge.
- Failed battery as a result of under/overcharge.
- Repeat alternator replacement or misdiagnosis.
- Other vehicle electrical issues.

# Voltage Drop Testing

## Performing a Voltage Drop Test

While these tests are most accurate with the aid of a carbon pile, we'll review how to perform these tests using the vehicle as the load.

*Note: There **must** be current flow for voltage drop to occur. For this reason, you cannot perform this voltage drop test on a vehicle with a failed charging system. Make the necessary repairs to the charging system before conducting this voltage drop test.*

**STEP 1:** Start the engine and hold at about 2000 RPM. Turn on all possible electrical loads:

- Headlamps on high beam.
- Blower motor on high speed.
- Any other accessories that require electrical power.

**STEP 2:** Measure the voltage at the alternator by placing the black lead of the voltmeter on the case of the alternator and the red lead of the voltmeter on the alternator B+.

- If the reading is 12.6 volts or less, repair the charging system and repeat this test.
- If the reading is greater than 12.6 volts, record the reading and proceed to Step 3.

**STEP 3:** Measure the voltage at the battery by placing the black lead of the voltmeter on the negative battery terminal and the red lead of the voltmeter on the positive battery terminal.

- If the reading is within 0.4 volts of the Step 2 results, the charging system power and ground are within specifications. Proceed to Step 6.
- If the reading is more than 0.4 volts from the Step 2 results, then proceed to Step 4 to isolate the failed circuit.

**STEP 4:** Measure positive circuit voltage drop by placing the black lead of the voltmeter on the positive battery terminal and the red lead of the voltmeter on the alternator B+ post.

- If the reading is less than 0.03 volts, verify the alternator is charging and retest. If the reading is between 0.03 and 0.20 volts, the positive circuit is within specification and you can proceed to Step 5.
- If the reading is greater than 0.20 volts, inspect and repair the positive circuit from the battery to the B+ post of the alternator. Be sure to closely inspect for corrosion, loose connections, or failing fusible links.

**STEP 5:** Measure negative circuit voltage drop by placing the black lead of the voltmeter on the housing of the alternator and the red lead of the voltmeter on the negative battery terminal.

- If the reading is less than 0.03 volts, verify the alternator is charging and retest.
- If the reading is between 0.03 and 0.20 volts, the negative circuit is within specification and you can proceed to Step 6.
- If the reading is greater than 0.20 volts, inspect and repair the negative circuit from the battery to the alternator housing. Remember to closely inspect for corrosion, loose connections, and that the alternator brackets are both securely mounted and corrosion-free.

**STEP 6:** If the vehicle you are working on has a voltage sense line, verify sense voltage drop as well. If you are uncertain about the vehicle you are working on, consult the wiring diagram or contact Remy technical support. Place the black lead of the voltmeter on the case of the alternator and back probe the sense line with the red of the voltmeter.

- If the reading is within 0.2 volts of the Step 2 results, the sense line is within specification.
- If the reading is greater than 0.2 volts of the Step 2 results, then inspect and repair the sense line back to the source voltage.

**The example picture is specified for Ford Vehicles. Sense line location varies by manufacturer.**





# Controller Area Network (CAN)

Modern CAN systems are complex.

Need to reduce BUS load, for high speed communications, EPAS Systems and future Autonomous driving vehicles.

Controller Area Network (CAN)

Data communication protocol:

- One wire, twisted pair wires or fiber optic cable bi-directional communication.
- Can use different bus speeds.
- Less expensive (compared to traditional vehicle wiring).
- Voltage signal less susceptible to EMI (Electromagnetic Interference).
- More flexible system, generic controllers can be used.
- Lowers controller current flow requirements.

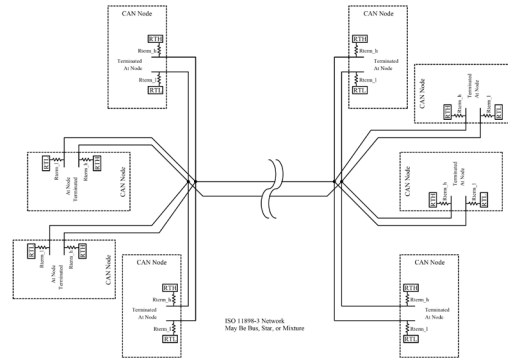

# Local Interconnect Network (LIN)

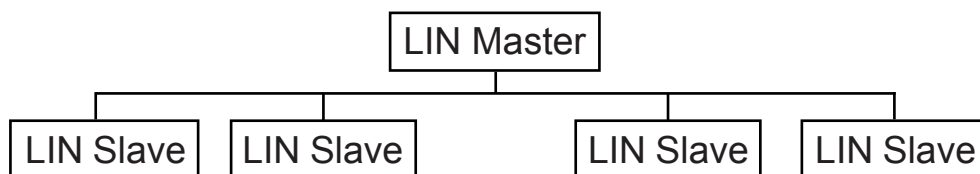

- More economical than CAN networks where speed is less important.
- Up to 20 kbps.
- Each LIN Master can have up to 16 LIN Slaves Common.
- Developed as a sub-network of CAN to reduce the Bus Load.

Implementation:

- Charging Systems
- Climate Control
- Windshield Wipers
- Power Windows
- Power Seats

# Ford Smart Regenerative Charge System

## Ford's Third Version of Smart Charge (LIN)

### Smart Charging System

- The Ford Smart Regenerative Charge System was first introduced in the 2012 Focus.
- It represents Ford's first implementation of LIN networks into the charging system.
- Scan tool / oscilloscope required for detailed diagnosis.

### Body Control Module

- Determines optimal charging voltage based on vehicle conditions and battery SOC.
- Communicates desired setpoint to the PCM over the High Speed CAN Network.
- Initiates Load Shedding when battery SOC drops below set value.
- Sends charging system failure status and Load Shedding initiation information to the IPC.

### Battery Monitoring Sensor

#### Measures:

- Battery Current Flow
- Battery Voltage
- Battery Temperature (Battery State of Charge)

#### Communications:

- Communicates information to the BCM over the LIN Network.
- Communicates internal errors in the sensor to the BCM.

### Powertrain Control Module

- Receives the desired setpoint from the BCM and makes any necessary changes to the setpoint based on engine operating strategies.
- Commands Soft Start and Load Response Control values.
- Communicates desired setpoint to the Alternator over the LIN Network.
- Sends Charge lamp and message center requests to the BCM over the HS CAN Network.

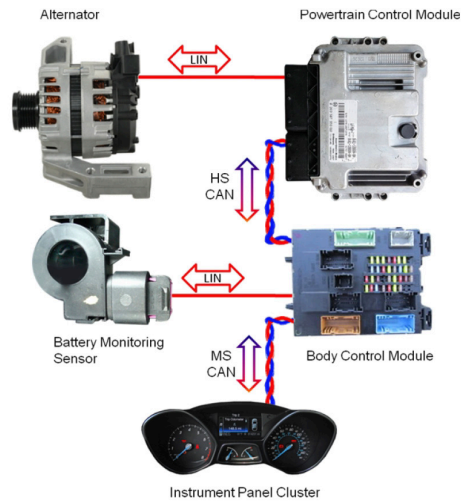

### Alternator / Generator

- Receives the desired setpoint from the PCM and adjusts field strength to maintain the setpoint.
- Communicates Load and diagnostic information to the PCM over the LIN Network.
- Has internal default of 13.8v in the event of LIN circuit failure.

### Instrument Panel Cluster

- Receives the charge lamp and message center commands from the BCM over the Medium Speed CAN Network.
- Receives Load Shedding message center command from BCM.

### Battery Monitoring System (BMS)

- Battery Refresh Phase
- Load Shed
- Sensor Calibration

### Reminder:

Jump Starting and Battery Charging MUST be done from engine ground, NOT from battery ground to prevent unit from entering load shed.

# Ford Smart Regeerative Charge System

## Ford Smart Charge

### Ford Application: Alternator GENCOM and GENMON Signals

The Ford Smart Charge System was introduced in the 1999 Ford Windstar and has continually evolved to include all applications as well as additional modules, sensors and strategies. By understanding the alternator command and feedback signals, referred to as GENCOM and GENMON, you will be better able to diagnose charging system issues. Because charging system codes do not turn on the check engine light, scan tool diagnosis is always required.

**Reminder:** Fully charge and load test the battery before beginning. A partially charged or failing battery will result in incorrect test results. Do not have a battery charger attached during vehicle testing.

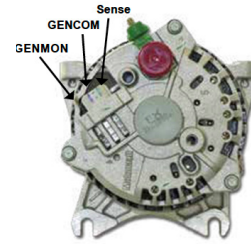

(Figure 1)

### Default Charging

Before conducting any tests, retrieve all diagnostic codes. Diagnostic testing will cause codes to set, which can later be misinterpreted as a vehicle concern. The alternator will default charge at ~13.7 volts when there are vehicle concerns with GENCOM or GENMON. Depending upon the type of failure, the PCM may command a high voltage set point, and then switch to default at timed intervals, making the voltage fluctuate.

To manually put the vehicle in a fixed default mode, disconnect the 3-pin regulator connector at the alternator, start the vehicle, and increase engine rpm to 2500 briefly. The alternator will default charge at ~13.7 volts depending upon vehicle electrical demands. While the vehicle is in default mode, load the alternator and perform power and ground voltage drop tests.

### GENCOM Diagnosis

GENCOM is the PCM-commanded voltage set point sent to the regulator (within the alternator). The voltage source for the signal originates at the regulator, and the PCM modulates the signal to ground with a variable duty cycle signal. The signal is approximately 128 Hz but varies based on specific regulator. The duty cycle command varies from 3 - 95%. The higher the duty cycle, the higher the commanded voltage set point. It is important to remember that most versions of Ford Smart Charge will have no command present if the alternator is performing as desired.

- With the key in the off position, disconnect the 3-pin regulator connector and measure voltage in the center pin of the regulator (Figure 1). Voltage should be 7.5 volts or higher and is most commonly near battery voltage (regulator dependent). If voltage is less than 7.5 volts, and the alternator has adequate power and ground, replace the alternator.
- Reconnect the regulator connector and carefully back probe GENCOM. Start the vehicle while monitoring duty cycle or DC voltage on the wire.
  - On initial startup you may notice a ~3% duty command (~.3 - .5 volts). This start-up mode reduces engine load during the crank cycle.
  - After startup you will see a command anywhere from ~35 – 65% duty cycle (4–9 volts). (The exact values are vehicle and system voltage dependent.)

# Ford Smart Regeerative Charge System

## Ford Smart Charge

Once the vehicle is stable, add loads by turning on the headlamps, wipers and other accessories. The value should rise in both duty cycle and voltage. Remember, the command may not always be present. If there is no command, adding loads to the vehicle should always result in a new PCM command.

- If duty cycle and/or voltage remain high and do not fluctuate, check the GENCOM wire for an open, or a potential PCM failure.
- If duty cycle and/or voltage are low and do not fluctuate, check the regulator connector for open, GENCOM for short to ground, and—although very unlikely—a failed PCM.
- If duty cycle and/or voltage respond similarly to the above description, GENCOM is operating normally. However, problems in the GENMON circuit can result in GENCOM codes because the PCM cannot verify the command was received by the regulator.

### GENMON Diagnosis

GENMON is the alternator load information provided to the PCM by the regulator. The voltage source for the signal originates at the PCM, and the regulator modulates the signal to ground with a variable duty cycle signal. The signal is approximately 128 Hz, but varies based on specific regulator. The duty cycle command varies from 5-95%. The higher the duty cycle, the higher the load. GENMON should have a signal anytime the alternator is operating.

- With the key in the off position, disconnect the 3-pin regulator connector, turn the key to the on position, and measure voltage on the GENMON pin of the wiring harness connector, (Figure 2). The voltage should be near battery voltage. If voltage is low check the GENMON circuit for short to ground or high resistance short. If the harness checks ok, the PCM is likely failed.
- Turn the key off and reconnect the regulator connector. Carefully back probe the GENMON terminal (Figures 1 & 2). Start the vehicle and monitor the duty cycle and/or voltage. There is no fixed value—it is dependent upon battery SOC and vehicle loads. Once the vehicle has stabilized, add loads. The duty cycle and/or voltage should rise. Turning off loads should result in a decrease.

- If the duty cycle and/or voltage do not rise and fall with corresponding changes in loads, inspect the alternator connector, verify alternator power and ground circuits, and replace the alternator.

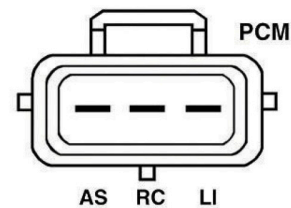

#### Terminal Markings

AS = Sense  
RC = GenCom  
LI = GenMon

(Figure 2)

### Sense Circuit, B+ Power and Ground Circuits

Fluctuating, low and high voltage can all be caused by the sense circuit, as well as alternator B+ and ground. These conditions—common in Ford applications—are diagnosed daily by the technical support team. Applied voltage must match system voltage, and more importantly, voltage drop cannot exceed .2 volts in each of these circuits.

# GM Regulated Voltage Control (RVC) Computer Controlled Charging

## GM Application: Alternator P0621 and P062 Codes

GM RVC charging system voltage varies from approximately 11.5 to 15.5 volts. During fuel economy mode, when voltage is at the lowest, customers or technicians monitoring battery voltage may believe there is a charging system concern. Simply turning on all vehicle electrical items will cause a mode change and make the voltage rise. Conversely, when the system is in battery sulfation mode, voltage may rise as high as 15.5 volts for three to four minutes. When there is a legitimate failure in the system, the battery lamp will illuminate and/or diagnostic codes will be stored. This tech tip deals with diagnosing the two most common codes: P0621 and P0622.

**REMINDER:** Fully charge and load test the battery before beginning. A partially charged battery will result in incorrect test results. Do not have a battery charger attached during vehicle testing.

## DTC P0621: Alternator L Terminal Fault

The alternator L terminal is the turn on command for the charging system. The PCM sends a 5-volt variable duty cycle signal to command the alternator voltage set point between 11 and 15.5 volts.

The PCM sets code P0621 when the following conditions occur:

- The alternator L circuit has high voltage for greater than five seconds with Key On Engine Off (KOEO)
- The alternator L circuit has low voltage for greater than 15 seconds with Key On Engine Running (KOER)



1. With the key in the off position, using a pin, back probe the L circuit at the voltage regulator.



3. Ensure the KOER measures 3.5 to 5.5 volts.

- If the reading is 0 to 1.5 volts, verify power and ground to the alternator, then have the alternator bench tested.

- If the reading is greater than 1.5 and less than 3.5, verify PCM operation.

- If the reading is greater than 5.5 volts, test for a short to power.



2. Ensure the KOEO measures 0 to 1.5 volts.

- If the reading is 1.5 to 5.5 volts, check the alternator ground and have the alternator bench tested.

- If the reading is greater than 5.5 volts, check for a short to power.

# GM Regulated Voltage Control (RVC) Computer Controlled Charging

## DTC P0622: Alternator F Terminal Fault

The alternator F terminal is a duty cycle signal that reflects field operation. The PCM monitors the F terminal to determine the alternator's load on the engine. The PCM uses the information to adjust engine RPM and alternator voltage set point.

The PCM sets code P0622 when the following conditions occur:

- PCM detects a duty cycle signal greater than 65% for five seconds KOEO.
- PCM detects a duty cycle signal less than 5% for 15 seconds KOER.

1. Verify the F terminal signal by monitoring the F terminal Parameter Identification (PID) on your scan tool. In KOER state, the GEN-F signal should be between 5 - 95% duty cycle.

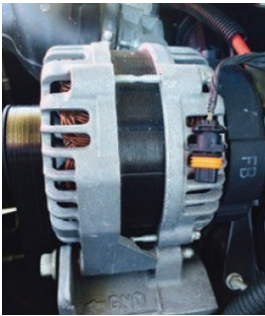

2. To test the F terminal (with the ignition off), unplug the voltage regulator connector.

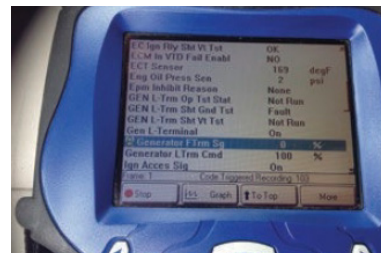

3. In KOEO state, monitor the GEN-F PID on the scan tool.

- The reading should be 0% duty cycle.
- If the duty cycle is higher, test for short to voltage.



4. Connect a test lamp to B+ and probe the voltage regulator harness at the F terminal.

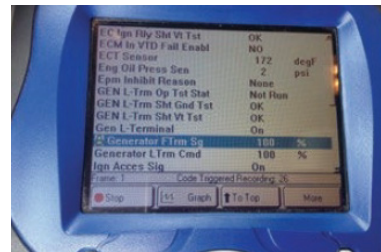

5. Monitor the GEN-F PID on the scan tool. The scan tool reading should read 95 - 100% duty cycle.

- If the duty cycle is below 5%, test for open or short to ground in the F circuit, then have the alternator bench tested.

# Chrysler Computer Controlled Charging

## ***Chrysler Application: Diagnostics for Alternator with Computer Controlled Charging System***

Chrysler computer-controlled charging systems set powertrain codes for field control circuit faults, as well as high and low voltage codes. These codes can reduce diagnostic time by focusing on specific circuits. This Technical Service Bulletin will address diagnosis from an under the hood testing perspective to help supplement the results of scan tool diagnosis.

Before you begin, ensure the battery is fully charged and passes capacity and/or load testing. Also inspect all wiring and connectors, check the alternator clutch pulley (if equipped) and verify belt condition using a belt wear gauge.

Chrysler alternators have external field terminal access. Testing an alternator independently from the control circuit is a straightforward task with only minor variation. However, when the alternator operates properly, the focus turns to control circuit and module diagnosis.

### **Multiple Field Terminals (Figure 1)**

Figure 1 shows a collection of connectors used on Chrysler alternators up to 2008. The terminals are labeled “F” for field: (F1) and (F2) or (F+) and (F-). Any indication of polarity does not affect alternator operation. Either wire can be hooked to either F terminal. When full power and ground are directly hooked to the field terminals it will operate at maximum output or full field.

### **Caution:**

In a full field state, voltage can quickly rise above 16 volts. Before beginning diagnosis, turn off all vehicle accessories and lamps. Any time voltage climbs to 16 volts or higher, quickly disable the charging system by opening the field circuit and/or turning the ignition key to the off position. While electronics are protected from voltage spikes, extended high voltage can cause electronics damage, premature bulb failure and potentially battery explosion. Observe all standard safety practices and do not allow a vehicle to run for an extended time with voltage beyond normal system voltage.

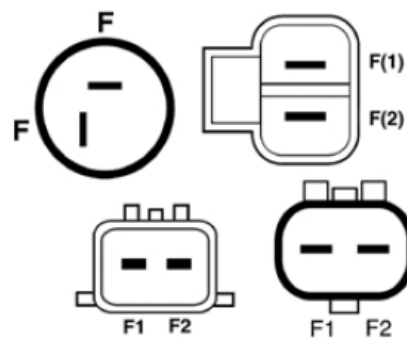

Figure 1

# Chrysler Computer Controlled Charging

## To test the alternator separate from the control circuit

1. Disconnect the 2-pin alternator connector.
2. Using insulated leads to prevent unintended shorts, attach one alternator field terminal to a known good ground.
3. Attach the second field terminal to one end of a fused jumper wire (10 amp fuse) and place the other end near a voltage source—but do not attach it yet.
4. Set up your voltmeter to monitor charging system voltage. (Black lead to known good ground; red lead to the B+ post of the alternator.)
5. Start the engine and bring to about 1500 RPM.
6. While closely monitoring charging system voltage, attach the fused jumper wire to positive post on the battery.

**The result:** The alternator is considered functional if voltage rises above battery voltage. If voltage rises to 16 volts or higher, quickly disconnect the fused jumper wire to prevent system damage. If the voltage does not rise, it is an indication of alternator failure. However before replacing the alternator, verify alternator power and ground circuits.

## Single Field Terminal (Figure 2)

In 2008, Chrysler alternators began using a single field terminal. Figure 2 shows the latest design connector, which can be visually identified by the connector tab location, or by the proximity of the terminals to the connector body. These applications have a single field wire. The second terminal is labeled “B,” “Sense” or “Kelvin sense,” and used by the PCM to monitor charging voltage. The procedure for testing these units is the same as for the multiple field terminal— except you will not perform step 2. There is no external ground connection to the field and there is no connection made to the “sense” terminal.

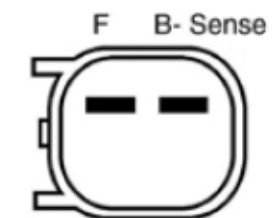

### Terminal Markings

F = Field

B = Kelvin Sense

Figure 2



# Chrysler Computer Controlled Charging

## Setpoint Regulation

To maintain the desired voltage setpoint, the regulator (PCM) controls either the power or ground circuit of the rotor to maintain the proper magnetic field strength. The required current flow of the rotor varies based on vehicle demand, battery state of charge and engine RPM. Chrysler applications have used both A and B side regulation.

- A circuit: Power is applied to one field terminal either from the automatic shutdown relay or directly from the PCM (Pin 1 of Figure 3). On the second field terminal, ground to the rotor is varied by the PCM with a duty cycle to maintain the desired setpoint (Pin 2 of Figure 3).
- B circuit: Ground is applied to one field terminal (Pin 1 of Figure 4). On the second field terminal, battery voltage to the rotor is varied by the PCM with a duty cycle to maintain the desired setpoint (Pin 2 of Figure 4 or Pin 1 of Figure 5).

## Diagnosis of control circuits

Dual field applications can be A or B side controlled, based upon application. Consult the wiring diagram for your application to verify A or B side regulation. Single field applications are always B side controlled.

### Dual Field "A" circuit (Figure 3)

Back probe both field terminals at the alternator. With the engine running at 1500 RPM, monitor the wires. One field wire should be near system voltage (within .5 volts) at all times (Pin 1 of Figure 3). If it is any other value, repair the voltage supply circuit. The other field wire will vary based on battery state of charge and load (Pin 2 of Figure 3). Monitor the field control circuit while adding and removing loads. The voltage should rise with increasing loads. If the voltage remains high and does not fluctuate with changing loads, the field wire is shorted to power, open or the PCM circuitry is failed. If the voltage remains low, verify alternator operation and/or repair the field circuit for short to ground.

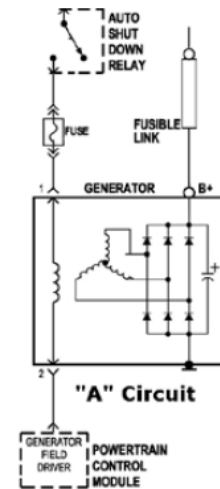

Figure 3

### Dual Field "B" circuit (Figure 4)

Back probe both field terminals at the alternator. With the engine running at 1500 RPM, monitor the wires. One field wire should be between .05 and .5 volts at all times (Pin 1 of Figure 4). If it is greater than .5 volts repair the field ground. If it is 0 volts, then verify voltage on the second field wire and/or test the alternator. The second field wire will vary based on battery state of charge and load (Pin 2 of Figure 4). Monitor the circuit while adding and removing loads. The voltage should rise with increasing loads. If the voltage remains high and does not fluctuate with load, check the harness for a short to power. If the voltage is 0 volts (within .5 volts), the field wire is open shorted to ground or the PCM control circuit is failed.

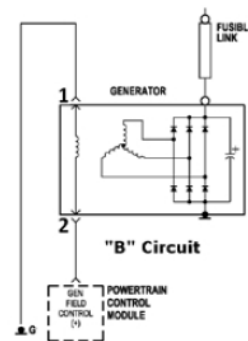

Figure 4

# Chrysler Computer Controlled Charging

## Single Field “B” circuit (Figure 5)

Back probe the field terminal at the alternator (Pin 1 of Figure 5). With the engine running at 1500 RPM, monitor the circuit. The circuit will vary based on battery state of charge and load. The voltage should rise with increasing loads. If the voltage remains high and does not fluctuate with load, check the harness for a short to power. If the voltage is 0 volts (within .5 volts), the field wire is open shorted to ground or the PCM control circuit is failed.

## Kelvin Sense “ G E N S E N S E ” (Figure 6, 6B)

By definition, a Kelvin connection is a means of making precision electrical potential contact with a current carrying component or reference point in such a way that eliminates or greatly reduces the effect of contact resistance. It is a very precise way to measure voltage. In order to get a very precise reading, the Kelvin Sense terminal is directly wired to the rectifier plate. The PCM directly monitors this circuit that has no current flow and therefore no voltage drop. Inside the alternator, the sense circuit does have a 2.4K ohm resistor to protect it from shorts to ground but because the circuit has no intended ground path, there is no current flow. The PCM also monitors system voltage through the fused B+ circuit coming from the PDC/TIPM. These two voltage inputs are compared when the PCM is performing the different diagnostics on the EVR system.

Testing the sense (Kelvin Sense) circuit: With the alternator connector plugged in, back probe the sense line

(Figure 6B). Before the vehicle is started, the voltage reading on the alternator sense circuit will be battery voltage as it is always hot. With the vehicle running, the sense voltage should be approximately 3.5V less than system voltage at the alternator B+ stud due to the resistor inside the alternator.

After completion of any charging system repairs, it is critical to perform power and ground voltage drop tests to help ensure root cause has been repaired. (See our Dec. 2015 issue for more on voltage drop tests.)

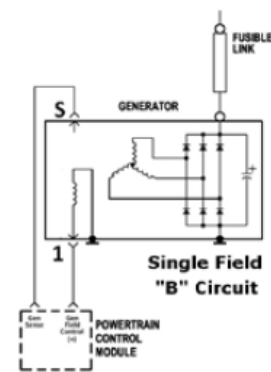
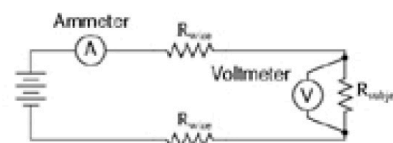

Figure 5



$$R_{\text{subject}} = \frac{\text{Voltmeter indication}}{\text{Ammeter indication}}$$

Figure 6

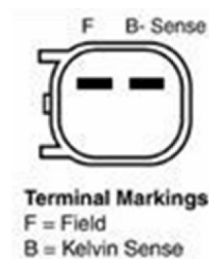

Figure 6B

# Toyota / Lexus

Result of Logic Operation (RLO) is a PCM generated signal that allows the alternator to adjust set point based on information from the battery current and battery temperature sensors. The RLO terminal is connected to the car ECU/ECM that is then connected to a **sensor on or near the battery**. This sensor continuously measures the state of the battery and this signal has a block pulse with a very low Hertz frequency (7,5Hz).



DENSO

## Third generation LIN controlled

The power generation voltage variable control enables fuel consumption to be decreased by reducing the engine load which is caused by the power generation of the generator. The battery current sensor is installed to the battery cable at the negative terminal. The sensor measures the charging/discharging current of the battery. Based on the sensor signal, Engine Control Module (ECM) judges whether or not the power generation voltage variable control is performed.

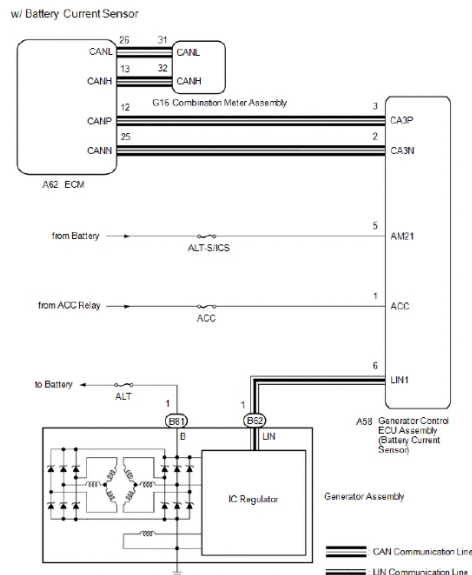

## Alternator Management System

Alternator management system controls the charging voltage set point in order to improve fuel economy, manage alternator load under various operating conditions, keep the battery charged and protect the battery from over-charging. ECM controls generating voltage by duty cycle (charging control, discharging control, normal control) based on the battery conditions and vehicle operating conditions.

The system conducts discharging control when accelerating a vehicle. Vehicle reduces an alternator load and consumes an electric power from a battery. The system conducts charging control when decelerating a vehicle. Vehicle increases an alternator load and charges a battery.

- Always retrieve charging system codes *before* beginning diagnosis.
- Always clear charging system codes *after* completing diagnosis.
- Always verify lamp circuit operation.

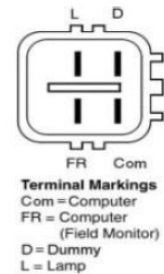

**REMINDER:** Fully charge and load test the battery before beginning. A partially charged or failing battery will result in incorrect test results. Do not have a battery charger attached during vehicle testing.

Back probe the COM circuit. This is the PCM communicating voltage setpoint to the alternator.

- Start the engine and hold rpm above idle speed.
- Slowly add loads to the vehicle.
- Because there are two systems, depending on model, you may get one of two results:
  - The voltage will increase as loads are added, OR
  - The voltage will decrease as loads are added.

Back probe the FR circuit. This is the alternator communicating load information to the PCM.

- Start the engine and hold rpm above idle speed.
- Slowly add loads to the vehicle.
- Because there are two systems, depending on model, you may get one of two results:
  - The voltage will increase as loads are added, OR
  - The voltage will decrease as loads are added.
- Verify Base Alternator Operation:
  - With the regulator unplugged, start the engine and rev to 1500 rpm to initiate default charging.
  - The alternator should charge at about 14.5 volts.

# Honda / Acura

## Dual Mode Charging System

---

### ***Operation, Diagnostic and Troubleshooting Procedures:*** **Honda / Acura Model Years 1990-2012**

#### **Honda/Acura Dual Mode System Operation (Normal and Low)**

For many years, Honda and Acura have utilized a dual mode charging system to increase fuel efficiency and to decrease the drag on the engine when starting.

The two modes can accomplish as much as a 10% load reduction on the engine by allowing the Powertrain Control Module (PCM) to determine charging rates based on information gathered from the Electrical Load Detector (ELD) unit as well as other sensors. During heavy electrical or mechanical loads, the PCM will set the charging voltage to 13.5 -14.9V (normal output mode). During startup and light electrical load conditions, the PCM will set the charging voltage to 12.4 -12.9V (low output mode). In the case of the latter, this anomaly may cause a technician to incorrectly diagnose a low charge problem, even though it is normal to have 12.4 -12.9V charging voltage when the parameters are met. With the battery at a high state of charge, the pressure (voltage) does not have to exceed the battery voltage to push amperage into it. However, amperage will flow from the alternator to maintain this state of charge and supply the vehicle's electrical needs.

#### **Normal Mode**

When the key is turned to the on position, the alternator receives 12V over the Ignition (IG) circuit to turn on the alternator.

The alternator looks at the Computer (C) circuit voltage to determine the charge rate and begins to build the magnetic field. The PCM supplies a 5V reference over the Monitor (FR) wire. The regulator toggles the FR to ground, creating a variable duty cycle and indicating a charging system load. The regulator determines there is a no charge condition (the vehicle isn't running yet), and grounds the Lamp (L) wire to indicate to the PCM of the no charge condition.

In response, the PCM commands the Gauge Control Module (GCM) to turn on the battery lamp over the Controller Area Network (CAN). When the vehicle is started, the regulator sees the rise in voltage and releases the ground on the L circuit. The PCM commands the GCM to turn off the battery lamp over the CAN. The alternator then supplies the current to support the loads of the vehicle and recharge the battery, if needed.

Normal mode voltage set point is 13.5-14.9V.

**Note:** Starting in 2003, the PCM commands the battery lamp. Prior to 2003, the battery lamp was controlled by the alternator regulator.

Batteries are perishable devices that eventually wear out as they deteriorate and become incapable of performing their job. In addition, new and/or good batteries may become discharged for various reasons. Because of this, a battery check should be the starting point for diagnosing all electrical system problems.

# Honda / Acura

## Dual Mode Charging System

### Operation, Diagnostic and Troubleshooting Procedures: Honda / Acura Model Years 1990-2012

#### Low Mode

The PCM monitors the FR circuit, ELD unit and vehicle conditions. When the vehicle amperage demands are low, the ELD indicates this and the PCM grounds the C wire. This causes the regulator to enter low mode and adjust the set point to 12.4 - 12.9V. When the vehicle amperage demand rises, the PCM releases the "C" terminal and returns the set point to normal mode.

#### REMEMBER:

- Always retrieve charging system codes before beginning diagnosis.
- Always clear charging system codes after completing diagnosis.
- Refer to wiring schematic for year, make and model.

### HONDA/ACURA DUAL MODE SYSTEM DIAGNOSIS & TROUBLESHOOTING Charging System DTCs

- A. P16BB Alternator B+ Circuit Low Voltage  
(Failed Alternator, Open B+, Loose Connections)
- B. P16BC Alternator FR/IG Circuit Low Voltage  
(Open IG circuit, Open or Grounded FR, Failed Alternator, Failed PCM)
- C. P0562 Charging System Low Voltage  
(Loose Connections, Failed Alternator)

#### Alternator Regulator Connectors

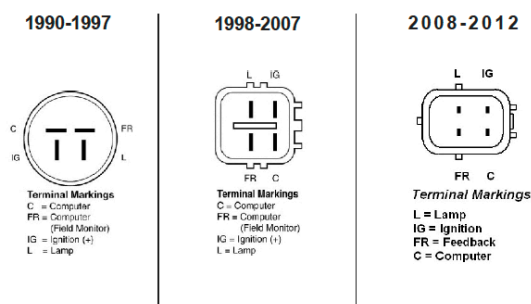

# Honda / Acura

## Dual Mode Charging System

### Operation, Diagnostic and Troubleshooting Procedures: Honda / Acura Model Years 1990-2012

#### Follow these steps to ensure proper diagnostics of the charging system:

1. Test the battery. Ensure battery is fully charged and passes capacity and/or load testing.
2. Perform a visual inspection under the hood. Verify all electrical connections, main cables and plugs are clean, tight and in good repair. Next, check belt and tensioner condition. Finally, verify the clutch pulley condition (if equipped) and that the alternator is mounted properly.
3. Verify alternator B+ voltage. Key off voltage should be near battery voltage. (If not, repair B+ cable and/or ground circuit). Fig. 1
4. Alternator not turning on: Back probe the "IG" terminal (This is the "Turn On" signal to the alternator).

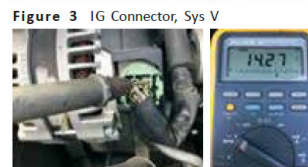

- Key off voltage should be 0 (If not, circuit short to voltage, faulty ignition switch)
- Key On Engine Off (KOEO) voltage should be near battery voltage Fig. 2
- Key On Engine Running (KOER) should be near system voltage (If not, circuit open, short to ground, faulty ignition switch) Fig. 3

5. Lamp circuit malfunction: Back probe the "L" terminal (Depending on the model year, this is alternator communication to the instrument cluster or PCM concerning alternator operation).

# Honda / Acura

## Dual Mode Charging System

### Operation, Diagnostic and Troubleshooting Procedures: Honda / Acura Model Years 1990-2012

- KOEO voltage should be less than 1V and the charge lamp should be illuminated (If not, bulb burned out, circuit short to "V", faulty PCM, alternator or Gauge Control Module) Fig. 4
- KOER voltage should be near system voltage and the lamp should be off (If not, circuit open, short to ground, faulty alternator, PCM, or Gauge Control Module) Fig. 5
- Alternator not charging: Back probe the "C" terminal (This is the Computer wire that is grounded by the PCM to command Normal and/or Low Mode).
- Normal mode KOER with 7V reference versions: Voltage will be equal to or greater than 7V (For 5V reference versions, voltage will be equal to or greater than 5V) Fig. 6
  - System voltage will be above 13.5V in normal mode (If not, circuit open, to ground, ELD, or PCM)
- Low mode KOER voltage should be less than 1V (while still back probing the C terminal) Fig. 7
  - System voltage should be between 12.4-12.9V in low mode (If not, circuit short to voltage, faulty ELD, or PCM)
- Alternator communication failure: Back probe the "FR" terminal (This is the "Monitor" wire the alternator toggles to ground to indicate charging system load).
- KOEO voltage should be less than 1V. (If not, circuit short to voltage, harness or faulty alternator) Fig. 8
- Normal mode KOER with high electrical loads: Voltage should decrease. (If voltage is below .27V, check for open or short to ground, faulty alternator or PCM) Fig. 9
- Low mode KOER with low electrical load: Voltage should be approximately 3.4-4.56V (If voltage is above 5V short to voltage, faulty alternator or PCM) Fig. 10

**Tip to remember:** Best practice is to perform a charging system voltage drop test before and after replacing the battery and/or alternator.

Figure 4 L Connector, less than 1V

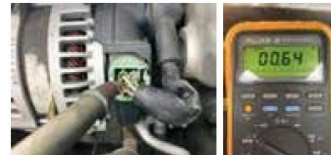

Figure 5 L Connector, Sys V

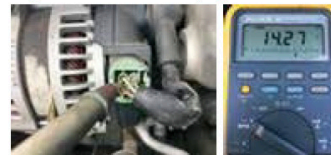

Figure 6 C Connector, greater than 7V

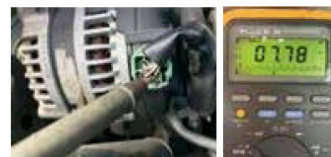

Figure 7 C Connector, less than 1V

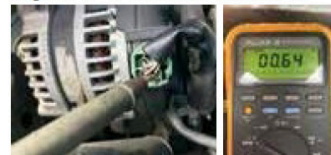

Figure 8 FR Connector, less than 1V

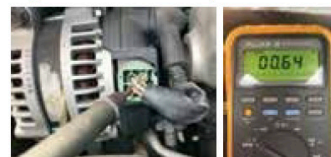

Figure 9 FR Connector, V decrease

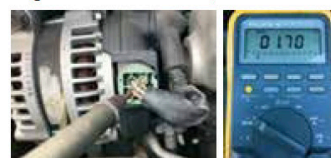
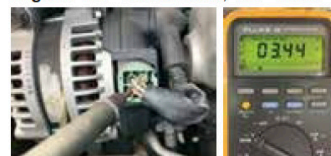

Figure 10 FR Connector, 3.4 - 4.56V





# Honda / Acura

## Dual Mode Charging System

### **Operation, Diagnostic and Troubleshooting Procedures:** **Honda / Acura Model Years 1990-2012**

#### **The Electrical Load Detector (ELD) Unit Operation**

The Electrical Load Detector (ELD) unit monitors the amount of amperage demand the vehicle is pulling from the battery. This amount varies depending on vehicle electrical loads. The PCM supplies a 5V reference to the ELD. The ELD will output .27 - 4.56V to the PCM. This reference voltage is what tells the PCM to increase or decrease the field strength in the alternator, which in turn increases or decreases the output of the alternator. The ELD pulls the voltage down as current to the vehicle increases. If the voltage on the reference is less than .27V or greater than 4.56V, the PCM detects a fault and sets a DTC.

**Note:** The ELD will not detect loads that are attached directly to the battery. Any accessories must be integrated into the vehicle's electrical system. Added accessories could overload the stock alternator.

#### **ELD Location**

The ELD is located inside of the under hood fuse box. The electrical connector will either plug into it from the top (Fig. 11) or plug into it from the bottom of the fuse box (Fig. 12). If the electrical connector plugs into the ELD from the bottom, the fuse box mounting screws will have to be removed, the fuse box lifted up and the cover removed to gain access to the connector.

#### **ELD DIAGNOSIS ELD DTCs**

- A. P1297: Electrical Load Detector (ELD) Circuit Low Voltage (Short to Ground, ELD Failure, PCM Failure)
- B. P1298: Electrical Load Detector (ELD) Circuit High Voltage (Open Power to ELD, Open ELD Ground, Open to PCM, Failed ELD)

#### **REMEMBER:**

- Always retrieve charging system codes before beginning diagnosis.
- Always clear charging system codes after completing diagnosis.
- Refer to wiring schematic for year, make and model.

Figure 11 ELD top fuse box

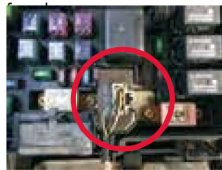

Figure 12 ELD bottom



# Honda / Acura

## Dual Mode Charging System

### **Operation, Diagnostic and Troubleshooting Procedures:** **Honda / Acura Model Years 1990-2012**

#### **Follow these steps for proper diagnostics of the ELD:**

1. Back probe the ELD connector's "B+" wire.
  - Key off voltage should be near battery voltage (If not, circuit open, short to ground) Fig. 13
2. Back probe the ELD connector's "Ground" wire.
  - Back probe the ELD ground wire. Connect the voltmeter positive lead to the battery positive. Connect the negative lead to the back probe pin. Voltage reading should be near battery voltage. (If not, circuit open) Fig. 14
3. Back probe the ELD connector's "PCM" reference wire.
  - Normal mode KOER voltage should decrease as load is added (If voltage is below .27V short to ground, ELD failure, PCM failure) Fig. 15
  - Low mode KOER voltage should be approximately 3.4-4.56V (If voltage is above 4.56V, open power to ELD, open ELD ground, open to PCM, ELD failure) Fig. 16

**Figure 13**  
ELD B+ conn



**Figure 14**  
ELD grnd conn

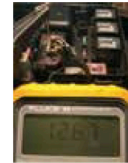

**Figure 15**  
ELD PCM V decrease



**Figure 16**  
ELD PCM 3.4-4.56

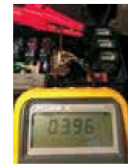

### **Honda EMS**

#### **Energy Management System (LIN)**

Beginning in 2012, Honda began using its latest charging system EMS. The description and operation is as follows:

- PCM commanded setpoint voltage
- Regulator with bi-directional LIN Communications
  - Receives PCM setpoint, Soft Start (SS) and Load Response Control (LRC) commands
  - Transmits alternator load and diagnostic information
- PCM monitored current demand of Vehicle through the ELD
- PCM monitored battery SOC
- PCM Commanded Battery Lamp

#### **Reminder:**

Scan tool / oscilloscope required for detailed diagnosis.





Technical Support Available Monday to Friday  
7am CST to 7pm CST  
[www.remyautomotive.com](http://www.remyautomotive.com)  
**1-800-280-2737**

